



## Installation and Operation Manual

Austa-1P6002G & Austa-1P8002G



Email: [marketing@austasolar.com](mailto:marketing@austasolar.com)  
Web: <https://www.austasolar.net>

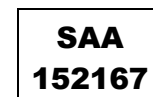

---

## CONTENTS

<b>COMPANY PROFILE</b>	<b>01</b>
<b>1. INTRODUCTION</b>	<b>02</b>
1.1 Prefix	02
1.2 Grid-tied PV System	02
1.3 How to Use This Manual	02
1.4 Label	02
<b>2. SAFETY INSTRUCTION</b>	<b>03</b>
<b>3. FCC COMPLIANCE</b>	<b>03</b>
<b>4. INSTALLATION</b>	<b>04</b>
Parts Included	04
Other Parts and Tools Required	04
Lightning Surge Suppression	04
Installation Procedure	04
Step 1 - Install the AC Branch Circuit Junction Box	05
Step 2 - Attach the AU-1P600/8002G to the Racking	06
Step 3 - Connect the AU-1P600/8002G Wiring Harnesses	07
Step 4- Ground the System	08
Step 5 - Complete the connection map and connect the PV Modules	09
<b>5. COMMISSIONING</b>	<b>10</b>
<b>6. OPERATING INSTRUCTIONS</b>	<b>11</b>
<b>7. TROUBLRSHOOTING MAINTENANCE</b>	<b>12</b>
<b>8. SPECIFICATION</b>	<b>14</b>
<b>9. WARRANTY AND PRODUCTION INFORMATION</b>	<b>16</b>

---

## COMPANY PROFILE

**AUSTA SOLAR** is a high-tech subsidiary company under OSDA Group, who started solar panel factory since 2009 located in Ningbo, China, including 6GW solar module production capacity.

**AUSTA SOLAR** started inverter R&D research in 2013. Our inverter technology was original from Germany inverter expert which was founded in 1993. We are always committed to the research, development, production and marketing of solar inverters and continue to pursue technological innovation.

Our main products are on grid inverter, microinverter, hybrid inverter, off grid inverter as well as several types of solar battery storage solutions etc. We devote our full energies to optimizing your residential, C&I rooftops by using the best matched inverters and panels. Our solutions have been involved into many different scenarios such as on grid, off grid, hybrid and mini grid applications. Till now, we have sold solar inverters to more than 46 countries and regions in Europe, Middle East, Southeast Asia, Africa, South America etc.

At present we have become one of major global suppliers for solar inverters.

We manufacture the innovation and reliability. We are dedicated to delivering the customers with our best solutions.

## 1. INTRODUCTION

### 1.1 Prefix

Dear customer, thank you for choosing the AU-1P600/8002G micro inverter from AUSTA. We hope you will find our products meet your need for renewable energy. Meantime, we appreciate your feedback regarding our products.

### 1.2 Grid-tied PV System

Grid-tied PV system consists of PV panels, grid-tied inverter and junction boxes. The DC output from the PV panels is converted into AC energy and feedback to the grid through the AU-1P600/8002G. AU-1P600/8002G PV micro inverter contains isolation transformer with basic insulation between PV input and AC grid output.







### 1.3 How to Use This Manual

This manual provides detailed product information and installation instructions for the AU-1P600/8002G micro solar inverter. Please read through this manual before installation and operation.

**WARNING:** This indicates a situation where failure to follow instructions may be a safety hazard or cause equipment malfunction. Use extreme caution and follow instructions carefully.

### 1.4 Label

Label is located on the side of the inverter. The information on the label includes technical data as well as type and serial number of the device. Safety instructions are listed and explained below:

	<b>Danger!</b> The term “danger” describes an issue which, if ignored can cause personal injury.
	<b>Attention!</b> With the term “attention” a circumstance is listed which may cause property damage if disregarded.
	<b>Instructions for use!</b> Under “Instructions for Use”, it is pointed out that installation and operating instructions are to be read and understood before installation or repair.
	<b>Caution, hot surface!</b> Under “Caution, hot surface”, it should be noted that surfaces of equipment may be hot and create a burn hazard.
	<b>Special disposal instructions!</b> With “Note Separate Disposal”, it is pointed out that this product may not be disposed of with normal garbage. An improperly conducted disposal can lead to damage to the environment.
	<b>CE mark</b> The product complies with essential requirements of relevant directives of EU

## 2. SAFETY INSTRUCTION

### WARNING:

PLEASE READ THIS MANUAL BEFORE INSTALLATION. ANY DAMAGE TO THE PRODUCT DUE TO NOT FOLLOWING THIS MANUAL IS NOT COVERED BY THE WARRANTIES.

ALL THE INSTALLATION SHOULD BE DONE BY CERTIFIED ELECTRICIAN.

BESIDES THE CABLE CONNECTORS, NOTHING INSIDE THE INVERTER SHOULD BE MODIFIED.

ALL INSTALLATION SHOULD FOLLOW THE LOCAL ELECTRIC CODES. FURTHER PROTECTION ON THE AC WIRING FROM THE INVERTERS SHOULD BE PROVIDED AND MAY BE REQUIRED BY LOCAL AND NATIONAL WIRING REGULATIONS. THIS PROTECTION IS LIKELY TO INCLUDE RESIDUAL CURRENT DEVICES, EARTH FAULT MONITORS AND CIRCUIT BREAKERS. THIS PRODUCT MAY CAUSE AC CURRENT WITH A DC COMPONENT. IF A RESIDUAL CURRENT-OPERATED PROTECTIVE DEVICE (RCD) OR A MONITORING DEVICE (RCM) IS USED FOR PROTECTION IN CASE OF DIRECT OR INDIRECT CONTACT, ONLY AN RCD OR RCM OF TYPE B IS ALLOWED ON THE AC SIDE OF THIS PRODUCT.

NEVER DISCONNECT PV MODULE FROM THE MICRO-INVERTER WITHOUT FIRST ISOLATING THE AC MAINS. ALL PV CONNECTORS AND AC CONNECTORS ARE FORBIDDEN TO BE DISCONNECTED UNDER LOAD BEFORE SWITCHING OFF THE CIRCUIT BREAKER ON THE AC BRANCH.

PLEASE CONTACT AUTHORIZED SERVICE AGENTS FOR ANY SERVICE WORK.

AU-1P600/8002G IS A GRID-TIED SOLAR INVERTER. IT MAY REQUIRE APPROVAL FROM LOCAL UTILITY COMPANY TO CONNECT IT TO THE POWER GRID.

AU-1P600/8002G DOES NOT INCLUDE COMPONENTS THAT CAN BE SERVED BY CUSTOMERS.

### WARNING:

WHEN THE PHOTOVOLTAIC ARRAY IS EXPOSED TO LIGHT, IT SUPPLIES A DC VOLTAGE TO THE MICRO-INVERTER.

## 3. FCC COMPLIANCE

This equipment has been tested and found to comply with the limits for a Class B digital device, pursuant to part 15 of the FCC Rules. These limits are designed to provide reasonable protection against harmful interference in a residential installation. This equipment generates uses and can radiate radio frequency energy and, if not installed and used in accordance with the instructions, may cause harmful interference to radio communications. However, there is no guarantee that interference will not occur in a particular installation. If this equipment does cause harmful interference to radio or television reception, which can be determined by turning the equipment off and on, the user is encouraged to try to correct the interference by one or more of the following measures:

- Reorient or relocate the receiving antenna.
- Increase the separation between the equipment and the receiver.
- Connect the equipment into an outlet on a circuit different from that to which the receiver is connected.
- Consult the dealer or an experienced radio/TV technician for help.

Changes or modifications not expressly approved by the party responsible for compliance may void the user's authority to operate the equipment.

## 4. INSTALLATION

**WARNING:** BE AWARE THAT INSTALLATION OF THIS EQUIPMENT INCLUDES RISK OF ELECTRIC SHOCK. NORMALLY GROUNDED CONDUCTORS MAY BE UNGROUNDED AND ENERGIZED WHEN A GROUND FAULT IS INDICATED.

### Parts Included

In addition to the micro inverters, PV modules, racking, and associated hardware, you'll need the AU-1P600/8002G installation kit. This kit includes the following items:

- Protective end cap
- Mounting Bracket (adapter plate)
- AC trunk cable, 6 feet length (option)

### Other Parts and Tools Required

In addition to your PV array and its associated hardware, you will need the following parts:

- Junction box
- Sockets, wrenches for mounting hardware

### Lightning Surge Suppression

Lightning does not actually need to strike the equipment or building where PV system is installed to cause damage. Often, a strike nearby will induce voltage spikes in the electrical grid that can damage equipment. AU-1P600/8002G has integrated surge protection, greater than most string inverters. However, if the surge has sufficient energy, the protection built into the AU-1P600/8002G can be exceeded, and the equipment can be damaged.

Since the AUSTA Limited Warranty does not cover "acts of God" such as lightning strikes, and since lightning strikes can occur anywhere, it is best practice to install surge protection as part of any solar installation. Installation of surge protection devices should follow vendor instructions.

### Installation Procedure

**WARNING:** DO NOT CONNECT AU-1P600/8002G TO THE UTILITY GRID OR ENERGIZE THE AC CIRCUIT(S) UNTIL YOU HAVE COMPLETED ALL OF THE INSTALLATION PROCEDURES AS DESCRIBED IN THE FOLLOWING SECTIONS.

Installing the AU-1P600/8002G Micro inverter System involves several key steps:

1. Measuring service and installing the AC branch circuit junction box.

**WARNING:** ONLY USE ELECTRICAL SYSTEM COMPONENTS APPROVED FOR WET LOCATIONS.

2. Attaching the AU-1P600/8002G Micro inverter to the racking.
3. Connecting the AU-1P600/8002G Micro inverter wiring harnesses.
4. Grounding the system (optional).
5. Completing the AU-1P600/8002G Micro inverter installation map and connecting the PV modules.

The finished system should be similar as in the diagram. Detailed installation steps are listed in the following section.

#### Step 1 - Install the AC Branch Circuit Junction Box

1. Measure service entrance conductors to confirm AC service at the site. Acceptable ranges are shown in the table below:

- AU-1P600/8002G-240-US & AU-1P600/8002G-208-US

240 Volt AC Single Phase		208 Volt AC Three Phase	
L1 to L2	240 Vac	L1 to L2	208 Vac

- AU-1P600/8002G-230-EU

L1 to L2	230 Vac
----------	---------

DC circuits of AU-1P600/8002G are isolated and insulated from ground. An integrated ground protection circuit is included in the micro inverter.

2. Mount the adapter plate at a suitable location on the PV racking system (typically at the end of a row of modules).
3. Install an appropriate junction box with the adapter plate.
4. Connect the open wire end of the AC interconnect cable into the junction box using an appropriate gland or strain relief fitting. The AC interconnect cable requires a strain relief connector with an opening of 3/8 inches in diameter.

### Step 2 - Attach AU-1P600/8002G to the Racking

1. Mark the approximate centers of each PV module on the racking system. Evaluate the location of the micro inverter with respect to the PV module junction box or any other obstructions.

**WARNING:** ALLOW A MINIMUM OF .75 INCHES BETWEEN THE TOP OF THE ROOF AND THE BOTTOM OF AU-1P600/8002G. WE ALSO RECOMMEND THAT YOU ALLOW .50 INCHES BETWEEN THE BACK OF THE PV MODULE AND THE TOP OF AU-1P600/8002G. DO NOT MOUNT AU-1P600/8002G IN A LOCATION THAT ALLOWS LONG-TERM EXPOSURE TO DIRECT SUNLIGHT.

2. Mount one micro inverter at each of these locations using hardware recommended by your module racking vendor

### Step 3 - Connect the AU-1P600/8002G Wiring Harnesses

Each AU-1P600/8002G comes with one 3-pin bulkhead receptacle mounted on the case. The three pins of this connector are for phases L1, L2 and ground. This AC connector is oppositely sexed with the connector at the end of the extension cable from the trunk cable through a T-connector. Plug the AC connector of the each AU-1P600/8002G into the connector of the extension cable to form a continuous AC branch circuit. Please check the rating label of the trunk cable for the maximum allowable number of AU-1P600/8002G on one AC branch circuit.

**WARNING:** DO NOT EXCEED THE MAXIMUM NUMBER OF AU-1P600/8002G IN AN AC BRANCH CIRCUIT, AS DISPLAYED ON THE UNIT-RATING LABEL. For 12AWG trunk cable, EACH AU-1P600/8002G AC BRANCH CIRCUIT MUST BE SOURCED FROM A DEDICATED BRANCH CIRCUIT PROTECTED BY A 20A MAXIMUM BREAKER.

Install a protective end cap on the open AC connector at the end of the truck cable.

**WARNING:** MAKE SURE PROTECTIVE END CAPS HAVE BEEN INSTALLED ON ALL UNUSED AC CONNECTORS. UNUSED AC AU-1P600/8002G WIRE HARNESS CONNECTORS ARE LIVE WHEN THE SYSTEM IS ENERGIZED BY THE UTILITY SYSTEM.

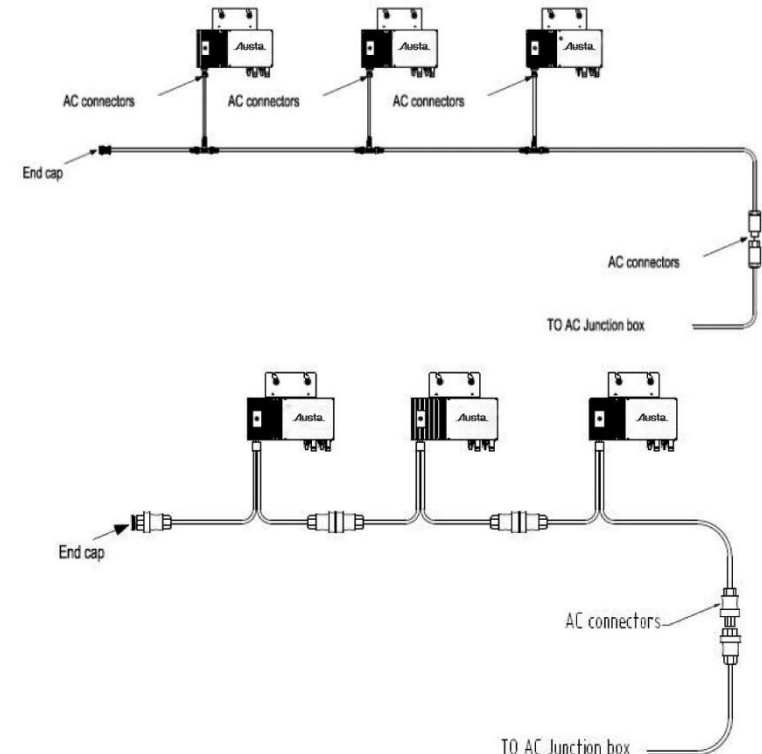

#### Step 4 – Ground the system

Each AU-1P600/8002G has an integrated ground protection circuit. The grounding wire is through the trunk cable, and should be securely connected to the ground connector in the junction box.

#### Step 5 – Ground the system through racking (option)

AU-1P600/8002G may also be grounded through the racking as shown below.

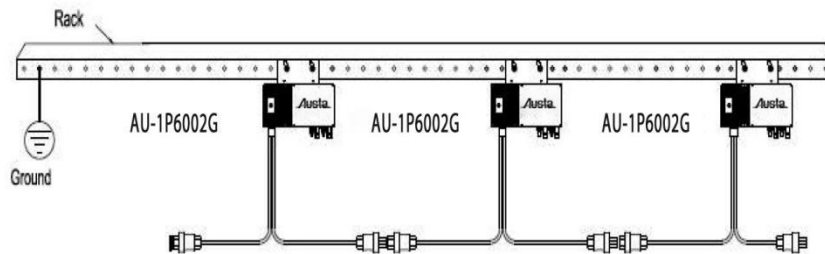
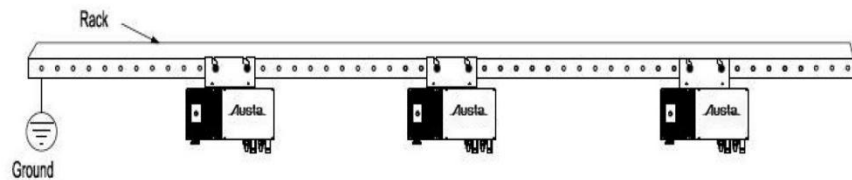

#### Step 6 – Complete the connection map and connect the PV Modules

AU-1P600/8002G connection Map is a diagrammatic representation of the physical location of each AU-1P600/8002G in your PV installation. The virtual array in AUSTA micro inverter gateway AUG-256 is created from the map you create.

#### Complete the connection map

Each AU-1P600/8002G has a removable serial number label located on the mounting plate. Enter this serial number into the AUG-256, and correspond it to a number in the connection map.

#### Connect the PV Modules

Completely install all AU-1P600/8002G and all system inter-wiring connections prior to installing the PV modules.

1. Mount the PV modules above their corresponding AU-1P600/8002G. Each AU-1P600/8002G comes with two oppositely sexed DC connectors.
2. First connect the positive DC wire from the PV module to the negatively marked DC connector (male pin) of the AU-1P600/8002G. Then connect the negative DC wire from the PV module to the positively marked DC connector (female socket) of the AU-1P600/8002G. Repeat for all remaining PV modules using one AU-1P600/8002G for each module.

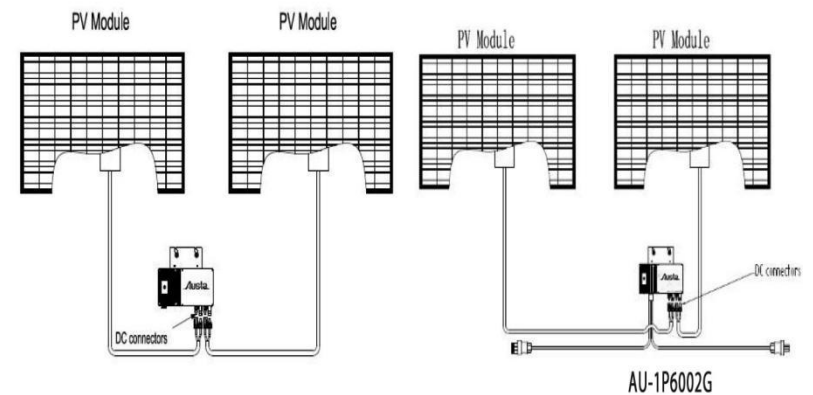

## 5. COMMISSIONING

**WARNING:** CONNECT AU-1P600/8002G TO THE ELECTRICAL UTILITY GRID ONLY AFTER RECEIVING PRIOR APPROVAL FROM THE UTILITY COMPANY.

**WARNING:** BE AWARE THAT ONLY QUALIFIED PERSONNEL CAN CONNECT AU-1P600/8002G TO THE ELECTRICAL UTILITY GRID.

**WARNING:** ENSURE THAT ALL AC AND DC WIRING IS CORRECT. ENSURE THAT NONE OF THE AC AND DC WIRES IS PINCHED OR DAMAGED. ENSURE THAT ALL JUNCTION BOXES ARE PROPERLY CLOSED.

Following these steps to commission the AU-1P600/8002G PV system:

1. Turn on the AC disconnects or circuit breakers on each AU-1P600/8002G AC branch circuit.
2. Turn on the main utility-grid AC circuit breaker. Your system will start producing power after a few minutes wait time.
3. The AU-1P600/8002G will start to send performance data over the power lines using power line communication (PLC) to the AUG-256. The time required for each AU-1P600/8002G in the system to communicate to the AUG-256 will vary with the number of AU-1P600/8002G in the system.

## 6. OPERATING INSTRUCTIONS

The AU-1P600/8002G is powered on when sufficient DC voltage from the module is applied. The status LED will start flashing after sufficient DC power is applied as an indication that the AU-1P600/8002G is live.

### Status: standby

The LED light is on by 2 second, and off by 2 seconds

Red: in error.

Orange: no error, but not communicating to AUG-256

Green: no error, and communicating to AUG-256

### Status: producing power

The LED light is on by 1 second, and off by 1 second.

Orange: not communicating to AUG-256

Green: communicating to AUG-256

### Status: grounding fault

The LED light is in *solid red* color.

In case of fault, AUM-250 has multiple protective functions and stops output power. The fault message may be sent to a connected AUG-256 gateway through power line communication. The error message is displayed on the screen of AUG-256 gateway by a 16-bit error code.

Error code	Error
Bit-0	DC over voltage
Bit-1	DC under voltage
Bit-2	hardware error
Bit-3	Inverter over voltage
Bit-4	Frequency over
Bit-5	Frequency under
Bit-6	AC voltage RMS over
Bit-7	AC voltage RMS under
Bit-8	Peak AC voltage over
Bit-9	AC current RMS over
Bit-10	Peak AC current over
Bit-11	Temperature over
Bit-12	ADC error
Bit-13	GFDI fault indicator
Bit-14	Relay fault (AUM-250-AU/AUM-250-EU only)
Bit-15	PLC Communication Error

## 7. TROUBLESHOOTING AND MAINTENANCE

**WARNING:** DO NOT ATTEMPT TO REPAIR THE AU-1P600/8002G; IT CONTAINS NO USER-SERVICEABLE PARTS. IF TROUBLESHOOTING METHODS FAIL, PLEASE RETURN THE AU-1P600/8002G TO YOUR DISTRIBUTOR FOR MAINTENANCE.

**WARNING:** NEVER DISCONNECT THE DC WIRE CONNECTORS UNDER LOAD. ENSURE THAT NO CURRENT IS FLOWING IN THE DC WIRES PRIOR TO DISCONNECTING. AN OPAQUE COVERING MAY BE USED TO COVER THE MODULE PRIOR TO DISCONNECTING

**WARNING:** AU-1P600/8002G IS POWERED BY DC POWER FROM PV MODULES. MAKE SURE YOU DISCONNECT THE DC CONNECTIONS AND RECONNECT DC POWER TO WATCH FOR THE TWO SECONDS LED ON AND TWO SECONDS LED OFF AFTER DC IS APPLIED.



**WARNING:** ALWAYS DISCONNECT AC POWER BEFORE DISCONNECTING PV MODULE WIRES FROM AU-1P600/8002G. THE AC CONNECTOR OF THE FIRST AU-1P600/8002G IN A BRANCH CIRCUIT IS SUITABLE AS A DISCONNECTING MEANS ONCE THE AC BRANCH CIRCUIT BREAKER IN THE LOADCENTER HAS BEEN OPENED.

### LED indication of error

- **error mode (except for grounding error)**

The LED light flashes in *red* color.

- **NOT communicating with AUG-256, and with no error**

The LED light flashes in *orange* color.

- **grounding fault**

The LED light is in *solid red* color.

### Troubleshooting an inoperable AUM-250

To troubleshoot an inoperable AU-1P600/8002G, follow the steps in the order shown:

1. Check the connection to the utility grid. Verify that the utility voltage and frequency are within allowable ranges shown in the label of AU-1P600/8002G.
2. Verify utility power is present at the inverter in question by removing AC, then DC power. Never disconnect the DC wires while the AU-1P600/8002G is producing power. Re-connect the DC module connectors, and then watch for the LED blinks.
3. Check the AC branch circuit interconnection harness between all the AU-1P600/8002G. Verify that each inverter is energized by the utility grid as described in the previous step.
4. Make sure that any AC disconnects are functioning properly and are closed.
5. Verify the PV module DC voltage is within the allowable range shown in the label of AU-1P600/8002G.
6. Check the DC connections between the AU-1P600/8002G and the PV module.
7. PLC signal quality may be checked through the interface on the AUG-256 gateway. If the PLC signal is weak, it might be due to the distance between the micro inverters and the gateway. It may also be caused by the interference from other electronic devices. In most cases, signal quality may be significantly improved by moving the AUG-256 to closer to the micro inverter arrays, and/or farther away from other interferers. In some cases, a signal filter (LCF) may be installed to reduce the interference to PLC communication. If there are two or more separate AUM systems close by, it is highly recommended to install LCF for each micro inverter system to block interference from adjacent other systems.
7. If the problem persists, please call customer support at AUSTA.

**WARNING:** DO NOT ATTEMPT TO REPAIR THE AU-1P600/8002G; IT CONTAINS NO USER-SERVICEABLE PARTS. IF TROUBLESHOOTING METHODS FAIL, PLEASE RETURN THE AU-1P600/8002G TO YOUR DISTRIBUTOR FOR MAINTENANCE.

### Disconnecting a AU-1P600/8002G from the PV Module

To ensure the AU-1P600/8002G is not disconnected from the PV modules under load, adhere to the following disconnection steps in the order shown:

1. Disconnect the AC by opening the branch circuit breaker.
2. Disconnect the first AC connector in the branch circuit.
3. Cover the module with an opaque cover.
4. Using a DC current probe, verify there is no current flowing in the DC wires between the PV module and the AU-1P600/8002G.
5. Care should be taken when measuring DC currents, most clamp-on meters must be zeroed first and tend to drift with time.
6. Disconnect the PV module DC wire connectors from the AU-1P600/8002G.
7. Remove the AU-1P600/8002G from the PV array racking.

### Installing a replacement AU-1P600/8002G

1. Attach the replacement AU-1P600/8002G to the PV module racking using hardware recommended by your module racking vendor
2. Connect the AC cable of the replacement AU-1P600/8002G and the neighboring AU-1P600/8002G to complete the branch circuit connections.
3. Complete the connection map and connect the PV Modules.
  - 1) Complete the connection map
  - 2) Each AU-1P600/8002G has a removable serial number located on the mounting plate. Enter this serial number into a AUG-256, and correspond it to a number in the connection map.
  - 3) Connect the PV Modules
  - 4) Completely install all AU-1P600/8002G and all system inter-wiring connections prior to installing the PV modules.
    - a) Mount the PV modules above their corresponding AU-1P600/8002G. Each AU-1P600/8002G comes with two oppositely sexed DC connectors.
    - b) First connect the positive DC wire from the PV module to the negatively marked DC connector (male pin) of the AU-1P600/8002G. Then connect the negative DC wire from the PV module to the positively marked DC connector (female socket) of the AU-1P600/8002G. Repeat for all remaining PV modules using one AU-1P600/8002G for each module.
4. Replace the old PLC\_ID in the AUG-256 gateway with the new PLC\_ID of the replacement micro inverter.

## 8. SPECIFICATION

MODEL		AU-1P6002G-230-EU
<b>INPUT(DC)</b>	Max Recommended PV Power (Wp)	480x 2
	Vmax PV (absolute maximum) (Vdc)	60
	PV Input Operating Voltage Range (Vdc)	22-55
	Maximum Operating PV Input Current (Adc)	28
	MPPT Tracking Accuracy	>99.5%
	Isc PV (absolute maximum) (Adc)	36
	Maximum Inverter Backfeed Current to the Array (Adc)	0
<b>OUTPUT(AC)</b>	Rated AC Output Power (W)	580
	Nominal Power Grid Voltage (Vac)	230
	Nominal Output Current (Aac)	2.5
	Current (inrush) (Peak and Duration)	24A, 15us
	Nominal Frequency (Hz)	50
	Power Factor	>0.99 (at rated power)
	Maximum Output Fault Current (Aac)	4.4A peak
	Maximum Output Overcurrent Protection (Aac)	10
	<b>SYSTEM EFFICIENCY</b>	CEC Efficiency
Night Time Tare Loss (W)		0.11
<b>PROTECTION FUNCTIONS</b>	Over/Under Voltage Protection	Yes
	Over/Under Frequency Protection	Yes
	Anti-Islanding Protection	Yes
	Over Current Protection	Yes
	Reverse DC Polarity Protection	Yes
	Overload Protection	Yes
	Ground Fault Detection	Integrated
	Protective Class	I
	IP Rating	IP66 / IP67
Environment Temperature	-40°C ~+65°C	
<b>OTHER PARAMETERS</b>	Display	LED LIGHT
	Communications	POWERLINE/WIFI
	Dimension (D-W-H mm)	277*132*50
	Weight(Kg)	2.9

MODEL		AU-1P8002G-230-EU
<b>INPUT(DC)</b>	Max Recommended PV Power (Wp)	600x 2
	Vmax PV (absolute maximum) (Vdc)	60
	PV Input Operating Voltage Range (Vdc)	22-55
	Maximum Operating PV Input Current (Adc)	34
	MPPT Tracking Accuracy	>99.5%
	Isc PV (absolute maximum) (Adc)	40
Maximum Inverter Backfeed Current to the Array (Adc)	0	
<b>OUTPUT(AC)</b>	Rated AC Output Power (W)	800
	Nominal Power Grid Voltage (Vac)	230
	Nominal Output Current (Aac)	3.48
	Current (inrush) (Peak and Duration)	9.4A, 15us
	Nominal Frequency (Hz)	50
	Power Factor	>0.99 (at rated power)
	Maximum Output Fault Current (Aac)	9.6A peak
Maximum Output Overcurrent Protection (Aac)	10	
<b>SYSTEM EFFICIENCY</b>	CEC Efficiency	96.9%
	Night Time Tare Loss (W)	0.11
<b>PROTECTION FUNCTIONS</b>	Over/Under Voltage Protection	Yes
	Over/Under Frequency Protection	Yes
	Anti-Islanding Protection	Yes
	Over Current Protection	Yes
	Reverse DC Polarity Protection	Yes
	Overload Protection	Yes
	Ground Fault Detection	Integrated
	Protective Class	I
	IP Rating	IP66 / IP67
Environment Temperature	-40°C ~+65°C	
<b>OTHER PARAMETERS</b>	Display	LED LIGHT
	Communications	POWERLINE/WIFI
	Dimension (D-W-H mm)	268*250*42
	Weight(Kg)	2.9

## 9. WARRANTY AND PRODUCTION INFORMATION

### What does this warranty cover and how long does it last?

This Limited Warranty is provided by Austa and covers defects in workmanship and materials in your AU-1P600/8002G Grid-Tied Inverter. This Warranty Period lasts for 10 years from the date of purchase at the point of sale to you, the original end user customer, unless otherwise agreed in writing. You will be required to demonstrate proof of purchase to make warranty claims.

This Limited Warranty is transferable to subsequent owners but only for the unexpired portion of the Warranty Period. Subsequent owners also require original proof of purchase as described in "What proof of purchase is required?"

### What will AUSTA do?

During the Warranty Period, Austa will, at its option, repair the product (if economically feasible) or replace the defective product free of charge, provided that you notify AUS of the product defect within the Warranty Period, and provided that AUSTA through inspection establishes the existence of such a defect and that it is covered by this Limited Warranty.

Austa will, at its option, use new and/or reconditioned parts in performing warranty repair and building replacement products. Austa reserves the right to use parts or products of original or improved design in the repair or replacement. Austa repairs or replaces a product, its warranty continues for the remaining portion of the original Warranty Period or 90 days from the date of the return shipment to the customer, whichever is greater. All replaced products and all parts removed from repaired products become the property of Austa.

### How do you get service?

If your product requires troubleshooting or warranty service, contact your merchant. If you are unable to contact your merchant, or the merchant is unable to provide service, contact AUSTA directly at:

**Email:** [info@austasolar.com](mailto:info@austasolar.com)

### What does this warranty not cover?

Claims are limited to repair and replacement or if in AUSTA's discretion that is not possible, reimbursement up to the purchase price paid for the product. AUSTA will be liable to you only for direct damages suffered by you and only up to a maximum amount equal to the purchase price of the product.

This Limited Warranty does not warrant uninterrupted or error-free operation of the product or cover normal wear and tear of the product or costs related to the removal, installation, or troubleshooting of the customer's electrical systems. This warranty

does not apply to and Austa will not be responsible for any defect in or damage to: a) the product if it has been misused, neglected, improperly installed, physically damaged or altered, either internally or externally, or damaged from improper use or use in an unsuitable environment; b) the product if it has been subjected to fire, water, generalized corrosion, biological infestations, or input voltage that creates operating conditions beyond the maximum or minimum limits listed in the Austa product specifications including high input voltage from generators and lightning strikes; c) the product if repairs have been done to it other than by AUSTA or its authorized service centers (hereafter "ASCs"); d) the product if it is used as a component part of a product expressly warranted by another manufacturer; e) the product if its original identification (trade-mark, serial number) markings have been defaced, altered, or removed; f) the product if it is located outside of the country where it was purchased; and g) any consequential losses that are attributable to the product losing power whether by product malfunction, installation error or misuse.

### Disclaimer Product

THIS LIMITED WARRANTY IS THE SOLE AND EXCLUSIVE WARRANTY PROVIDED BY AUSTA IN CONNECTION WITH YOUR AUSTA PRODUCT AND IS, WHERE PERMITTED BY LAW, IN LIEU OF ALL OTHER WARRANTIES, CONDITIONS, GUARANTEES, REPRESENTATIONS, OBLIGATIONS AND LIABILITIES, EXPRESS OR IMPLIED, STATUTORY OR OTHERWISE IN CONNECTION WITH THE PRODUCT, HOWEVER ARISING (WHETHER BY CONTRACT, TORT, NEGLIGENCE, PRINCIPLES OF MANUFACTURER'S LIABILITY, OPERATION OF LAW, CONDUCT, STATEMENT OR OTHERWISE), INCLUDING WITHOUT RESTRICTION ANY IMPLIED WARRANTY OR CONDITION OF QUALITY, MERCHANTABILITY OR FITNESS FOR A PARTICULAR PURPOSE. ANY IMPLIED WARRANTY OF MERCHANTABILITY OR FITNESS FOR A PARTICULAR PURPOSE TO THE EXTENT REQUIRED UNDER APPLICABLE LAW TO APPLY TO THE PRODUCT SHALL BE LIMITED IN DURATION TO THE PERIOD STIPULATED UNDER THIS LIMITED WARRANTY.

IN NO EVENT WILL AUSTA BE LIABLE FOR: (a) ANY SPECIAL, INDIRECT, INCIDENTAL OR CONSEQUENTIAL DAMAGES, INCLUDING LOST PROFITS, LOST REVENUES, FAILURE TO REALIZE EXPECTED SAVINGS, OR OTHER COMMERCIAL OR ECONOMIC LOSSES OF ANY KIND, EVEN IF AUSTA HAS BEEN ADVISED, OR HAD REASON TO KNOW, OF THE POSSIBILITY OF SUCH DAMAGE, (b) ANY LIABILITY ARISING IN TORT, WHETHER OR NOT ARISING OUT OF AUSTA'S NEGLIGENCE, AND ALL LOSSES OR DAMAGES TO ANY PROPERTY OR FOR ANY PERSONAL INJURY OR ECONOMIC LOSS OR DAMAGE CAUSED BY THE CONNECTION OF A PRODUCT TO ANY OTHER DEVICE OR SYSTEM, AND (c) ANY DAMAGE OR INJURY ARISING FROM OR AS A RESULT OF MISUSE OR ABUSE, OR THE INCORRECT INSTALLATION, INTEGRATION OR OPERATION OF THE PRODUCT.

IF YOU ARE A CONSUMER (RATHER THAN A PURCHASER OF THE PRODUCT IN THE COURSE OF A BUSINESS) AND PURCHASED THE PRODUCT IN A MEMBER STATE OF THE EUROPEAN UNION, THIS LIMITED WARRANTY SHALL BE SUBJECT TO YOUR STATUTORY RIGHTS AS A CONSUMER UNDER THE EUROPEAN UNION PRODUCT WARRANTY DIRECTIVE 1999/44/EC AND AS SUCH DIRECTIVE HAS BEEN IMPLEMENTED IN THE EUROPEAN UNION MEMBER STATE WHERE YOU PURCHASED THE PRODUCT. FURTHER, WHILE THIS LIMITED WARRANTY GIVES YOU SPECIFIC LEGAL RIGHTS, YOU MAY HAVE OTHER RIGHTS WHICH MAY VARY FROM EU MEMBERSTATE TO EU MEMBERSTATE OR, IF YOU DID NOT PURCHASE THE PRODUCT IN AN EU MEMBER STATE, IN THE COUNTRY YOU PURCHASED THE PRODUCT WHICH MAY VARY FROM COUNTRY TO COUNTRY AND JURISDICTION TO JURISDICTION.

## Warranty Card

### Customer Information

Name: \_\_\_\_\_

Address: \_\_\_\_\_

City: \_\_\_\_\_

State: \_\_\_\_\_

Zip Code: \_\_\_\_\_

Tel: \_\_\_\_\_

Fax: \_\_\_\_\_

E-mail: \_\_\_\_\_

### System Information

Fault Product(s) Serial Numbers: \_\_\_\_\_

System Commissioning Date: \_\_\_\_\_

Product Models: \_\_\_\_\_

No. of Products Used: \_\_\_\_\_

Bill of Lading Date: \_\_\_\_\_

Fault Product(s) Quantities: \_\_\_\_\_

Fault Time/Date: \_\_\_\_\_

Fault Message(s) or Code(s): \_\_\_\_\_

Brief Fault Description and Photos:

### Installation Information

Modules Used: \_\_\_\_\_

Modules Quantity: \_\_\_\_\_

Inverters quantity per string: \_\_\_\_\_

Installation Company Name: \_\_\_\_\_

Installer Name: \_\_\_\_\_

For the information on our warranty terms and conditions,  
please feel free to contact us.

All fields must be completed in order to process claim.

**Customer Signature:** \_\_\_\_\_ **Date:** \_\_\_\_\_



\*All rights reserved by AUSTA. This information is subject to changes without notice.



**Email:** [info@austasolar.com](mailto:info@austasolar.com)

**Web:** <https://www.austasolar.com/>